

BAUF

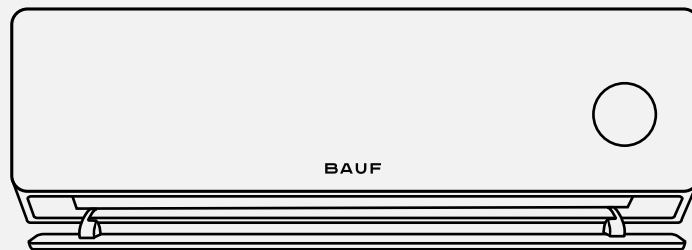

USER MANUAL NEUWIND



INDEX

1. Safety precautions	04
2. Name of parts	05
3. Operation instructions	06
4. Instruction for servicing(R32)	06
5. Installation precautions	09
6. Indoor unit installation	11
7. Outdoor unit installation	14
8. Test operation	16
9. Maintenance	17
10. Troubleshooting	18
11. Remote control	19

1. SAFETY PRECAUTIONS

SAFETY RULES AND RECOMMENDATIONS FOR THE INSTALLER

1. Read this guide before installing and using the appliance.
2. During the installation of the indoor and outdoor units, access to the working area should be forbidden to children. Unforeseeable accidents could happen.
3. Make sure that the base of the outdoor unit is firmly fixed.
4. Check that air cannot enter the refrigerant system and check for refrigerant leaks when moving the air conditioner.
5. Carry out a test cycle after installing the air conditioner and record the operating data.
6. Protect the indoor unit with a fuse of suitable capacity for the maximum input current or with another overload protection device.
7. Ensure that the mains voltage corresponds to that stamped on the rating plate. Keep the switch or power plug clean. Insert the power plug correctly and firmly into the socket, thereby avoiding the risk of electric shock or fire due to insufficient contact.
8. Check that the socket is suitable for the plug , otherwise have the socket changed.
9. The appliance must be fitted with means for disconnection from the supply mains having a contact separation in all poles that provide full disconnection under "over voltage category III conditions", and these means must be incorporated in the fixed wiring in accordance with the wiring rules.
10. The air conditioner must be installed by professional or qualified persons.
11. Do not install the appliance at a distance of less than 50 cm from inflammable substances (alcohol, etc.) Or from pressurized containers (e.g. spray cans).
12. If the appliance is used in areas without the possibility of ventilation, precautions must be taken to prevent any leaks of refrigerant gas from remaining in the environment and creating a danger of fire.
13. The packaging materials are recyclable and should be disposed of in the separate waste bins. Take the air conditioner at the end of its useful life to a special waste collection center for disposal.
14. Only use the air conditioner as instructed in this booklet. These instructions are not intended to cover every possible condition and situation. As with any electrical household appliance, common sense and caution are therefore always recommended for installation, operation and maintenance.
15. The appliance must be installed in accordance with applicable national regulations.
16. Before accessing the terminals, all the power circuits must be disconnected from the power supply.
17. The appliance shall be installed in accordance with national wiring regulations.
18. This appliance can be used by children aged from 8 years and above and persons with reduced physical, sensory or mental capabilities or lack of experience and knowledge if they have been given supervision or instruction concerning use of the appliance in a safe way and understand the hazards involved. Children shall not play with the appliance. Cleaning and user maintenance shall not be made by children without supervision.
19. Do not try to install the conditioner alone, always contact specialized technical personnel.
20. Cleaning and maintenance must be carried out by specialized technical personnel. In any case disconnect the appliance from the mains electricity supply before carrying out any cleaning or maintenance.
21. Ensure that the mains voltage corresponds to that stamped on the rating plate. Keep the switch or power plug clean. Insert the power plug correctly and firmly into the socket, thereby avoiding the risk of electric shock or fire due to insufficient contact.
22. Do not pull out the plug to switch off the appliance when it is in operation, since this could create a spark and cause a fire, etc.
23. This appliance has been made for air conditioning domestic environments and must not be used for any other purpose, such as for drying clothes, cooling food, etc.
24. Always use the appliance with the air filter mounted. The use of the conditioner without air filter could cause an excessive accumulation of dust or waste on the inner parts of the device with possible subsequent failures.
25. The user is responsible for having the appliance installed by a qualified technician, who must check that earthing/grounding is done in accordance with current legislation and insert a thermos magnetic circuit breaker.
26. The batteries in the remote controller must be recycled or disposed of properly. For disposal of scrap batteries, please discard the batteries as sorted municipal waste at the accessible collection point.
27. Never remain directly exposed to the flow of cold air for a long time. The direct and prolonged exposition to cold air could be dangerous for your health. Particular care should be taken in the rooms where there are children, old or sick people.
28. If the appliance gives off smoke or there is a smell of burning, immediately cut off the power supply and contact the Service Center

29. The prolonged use of the device in such conditions could cause fire or electrocution.
30. Have repairs carried out only by an authorised Service Center of the manufacturer. Incorrect repair could expose the user to the risk of electric shock, etc.
31. Unhook the automatic switch if you foresee not to use the device for a long time. The airflow direction must be properly adjusted.
32. The flaps must be directed downwards in the heating mode and upwards in the cooling mode.
33. Ensure that the appliance is disconnected from the power supply when it will remain inoperative for a long period and before carrying out any cleaning or maintenance.
34. Selecting the most suitable temperature can prevent damage to the appliance.

SAFETY RULES AND PROHIBITIONS

1. Do not bend, tug or compress the power cord since this could damage it. Electrical shocks or fire are probably due to a damaged power cord. Specialized technical personnel only must replace a damaged power cord.
2. Do not use extensions or gang modules.
3. Do not touch the appliance when barefoot or parts of the body are wet or damp.
4. Do not obstruct the air inlet or outlet of the indoor or the outdoor unit. The obstruction of these openings causes a reduction in the operative efficiency of the conditioner with possible consequent failures or damages.
5. In no way alter the characteristics of the appliance.
6. Do not install the appliance in environments where the air could contain gas, oil or sulphur or near sources of heat.
7. This appliance is not intended for use by persons (including children) with reduced physical, sensory or mental capabilities, or lack of experience and knowledge, unless they have been given supervision or instruction concerning use of the appliance by a person responsible for their safety.
8. Do not climb onto or place any heavy or hot objects on top of the appliance.
9. Do not leave windows or doors open for long when the air conditioner is operating.
10. Do not direct the airflow onto plants or animals.
11. A long direct exposition to the flow of cold air of the conditioner could have negative effects on plants and animals.
12. Do not put the conditioner in contact with water. The electrical insulation could be damaged and thus causing electrocution.

13. Do not climb onto or place any objects on the outdoor unit.
14. Never insert a stick or similar object into the appliance. It could cause injury.
15. Children should be supervised to ensure that they do not play with the appliance. If the supply cord is damaged, it must be replaced by the manufacturer, its service agent or similarly qualified persons in order to avoid a hazard.

2. NAME OF PARTS

Indoor Unit

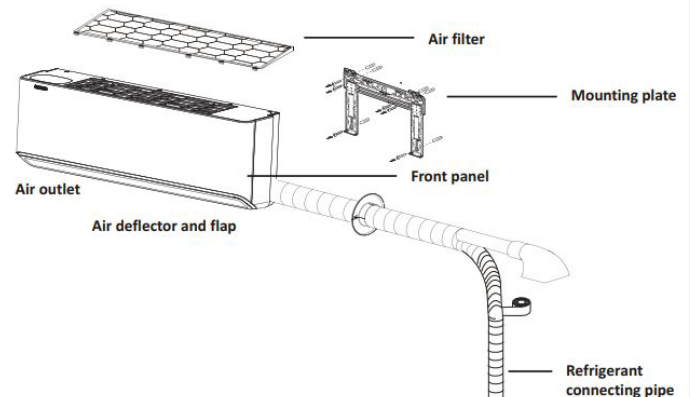

Outdoor Unit

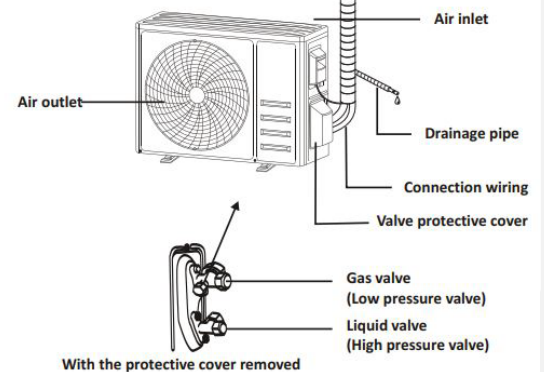

Note: This figure shown may be different from the actual object. Please take the latter as the standard.

Indoor Display

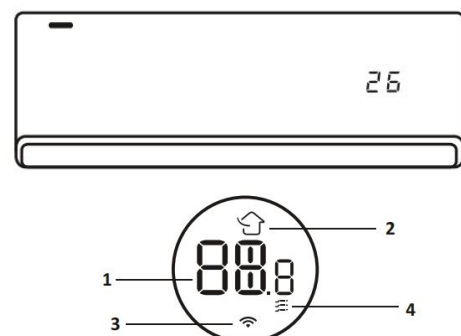

Nº	LED	Function
1		Indicator for Timer, temperature and Error codes.
2		Lights up when Fresh Air function is on.
3		Lights up when Wi-Fi is on
4		Lights up when Gentle Wind is on

Note:

The air conditioner automatically adjusts the display brightness and buzzer sound according to the ambient light intensity. When the air conditioner detects that the ambient light is weak for a period of time, it will automatically turn off the display temporarily. If there is a remote control or APP operation, the display will display at a low brightness for a short time, and the buzzer will respond at a lower volume; When the air conditioner detects that the ambient light is strong for a period of time, exit the above operation.



The shape and position of switches and indicators may be different according to the model, but their function is the same.

3. OPERATION INSTRUCTIONS

! Attempt to use the air conditioner under the temperature beyond the specified range may cause the air conditioner protection device to start and the air conditioner may fail to operate. Therefore, try to use the air conditioner in the following temperature conditions.

Inverter air conditioner:

Temperature / MODE	Heating	Cooling	Dry
Room temperature	0°C -27°C	17°C -32°C	
Outdoor temperature	-20°C -24°C	15°C -50°C Low temperature cooling: -15°C -50°C	

With the power supply connected, restart the air conditioner after shutdown, or switch it to other mode during operation, and the air conditioner protection device will start. The compressor will resume operation after 3 minutes.

! **Characteristics of heating operation (applicable to Heat pump models) Preheating:**
When the heating function is enabled, the indoor unit will take 2-5 minutes for preheating, after that the air conditioner will start heating and blows warm air.

Defrosting:
During heating, when the outdoor unit frosted, the air conditioner will enable the automatic defrosting function to improve the heating effect. During defrosting, the indoor and outdoor fans stop running. The air conditioner will resume heating automatically after defrosting finish.

! **Emergency button:**
Open the panel and find the emergency button on the electronic control box when the remote controller fails . (Always press the emergency button with insulation material.)

Current status	Operation	Respond	Enter mode
Standby	Press the emergency button once	It beeps briefly once	Cooling mode
Standby (Only for Heat pump models)	Press the emergency button twice in 3 seconds	It beeps briefly twice	Heating mode
Running	Press the emergency button once	It keeps beeping for a while	Off mode

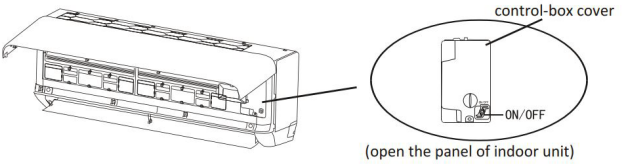

4. INSTRUCTION FOR SERVICING(R32)

1. Check the information in this manual to find out the dimensions of space needed for proper installation of the device, including the minimum distances allowed compared to adjacent structures.
2. Appliance shall be installed, operated and stored in a room with a floor area larger than 4m².
3. The installation of pipe-work shall be kept to a minimum.
4. The pipe-work shall be protected from physical damage, and shall not be installed in an unventilated space if the space is smaller than 4m²
5. The compliance with national gas regulations shall be observed.
6. The mechanical connections shall be accessible for maintenance purposes.
7. Follow the instructions given in this manual for handling, installing, cleaning, maintaining and disposing of the refrigerant.
8. Make sure ventilation openings clear of obstruction.
9. **Notice:** The servicing shall be performed only as recommended by the manufacturer.
10. **Warning:** The appliance shall be stored in a well-ventilated area where the room size corresponds to the room area as specified for operation.
11. **Warning:** The appliance shall be stored in a room without continuously operating open flames (for example an operating gas appliance) and ignition sources (for example an operating electric heater).
12. The appliance shall be stored so as to prevent mechanical damage from occurring.

13. It is appropriate that anyone who is called upon to work on a refrigerant circuit should hold a valid and up-to-date certificate from an assessment authority accredited by the industry and recognizing their competence to handle refrigerants, in accordance with the assessment specification recognized in the industrial sector concerned. Service operations should only be carried out in accordance with the recommendations of the equipment manufacturer. Maintenance and repair operations that require the assistance of other qualified persons must be conducted under the supervision of the person competent for the use of flammable refrigerants.

14. Every working procedure that affects safety means shall only be carried out by competent persons.

15. Warning:

- Do not use any means to accelerate the defrosting process or clean the frost on your own. Follow the recommended guidelines from the manufacturer.
- The appliance shall be stored in a room without continuously operating ignition sources (for example: open flames, an operating gas appliance or an operating electric heater).
- Do not pierce or burn.
- Be aware that refrigerants may not contain an odor



Risk of fire



Operating instructions



Read technical manual

16. Information on servicing:

- **Checks to the area.** Prior to beginning work on systems containing flammable refrigerants, safety checks are necessary to ensure that the risk of ignition is minimized. For repair to the refrigerating system, the following precautions shall be complied with prior to conducting work on the system.

- **Work procedure.** Work shall be undertaken under a controlled procedure so as to minimize the risk of a flammable gas or vapor being present while the work is being performed.

- **General work area.** All maintenance staff and others working in the local area shall be instructed on the nature of work being carried out. Work in confined spaces shall be avoided. The area around the workspace shall be sectioned off. Ensure that the conditions within the area have been made safe by control of flammable material.

- **Checking for presence of refrigerant.** The area shall be checked with an appropriate refrigerant detector prior to and during work, to ensure the technician is aware of potentially flammable atmospheres. Ensure that the leak detection equipment being used is suitable for use with flammable refrigerants, i.e. non-sparking, adequately sealed or intrinsically safe.

- **Presence of fire extinguisher.** If any hot work is to be conducted on the refrigeration equipment or any associated parts, appropriate fire extinguishing equipment shall be available to hand. Have a dry powder or CO₂ fire extinguisher adjacent to the charging area.

- **No ignition sources.** No person carrying out work in relation to a refrigeration system which involves exposing any pipe work shall use any sources of ignition in such a manner that it may lead to the risk of fire or explosion. All possible ignition sources, including cigarette smoking, should be kept sufficiently far away from the site of installation, repairing, removing and disposal, during which refrigerant can possibly be released to the surrounding space. Prior to work taking place, the area around the equipment is to be surveyed to make sure that there are no flammable hazards or ignition risks. "No Smoking" signs shall be displayed.

- **Ventilated area.** Ensure that the area is in the open or that it is adequately ventilated before breaking into the system or conducting any work that will produce heat. A degree of ventilation shall continue during the period that the work is carried out. The ventilation should safely disperse any released refrigerant and preferably expel it externally into the atmosphere.

- **Checks to the refrigeration equipment.** Where electrical components are being changed, they shall be fit for the purpose and to the correct specification. At all times the manufacturer's maintenance and service guidelines shall be followed. If in doubt consult the manufacturer's technical department for assistance.

- The following checks shall be applied to installations using flammable refrigerants:

- The charge size is in accordance with the room size within which the refrigerant containing parts are installed;

- The ventilation machinery and outlets are operating adequately and are not obstructed;

- If an indirect refrigerating circuit is being used, the secondary circuit shall be checked for the presence of refrigerant;

- Marking to the equipment continues to be visible and legible. Markings and signs that are illegible shall be corrected;

- Refrigeration pipe or components are installed in a position where they are unlikely to be exposed to any substance which may corrode refrigerant containing components, unless the components are constructed of materials which are inherently resistant to being corroded or are suitably protected against being so corroded.

- **Checks to electrical devices.** Repair and maintenance to electrical components shall include initial safety checks and component inspection procedures. If a fault exists that could compromise safety, then no electrical supply shall be connected to the circuit until it is satisfactorily dealt with. If the fault cannot be corrected immediately but it is necessary to continue operation, an adequate temporary solution shall be used. This shall be reported to the owner of the equipment so all parties are advised.

Initial safety checks shall include:

- That capacitors are discharged: this shall be done in a safe manner to avoid possibility of sparking;

- That no live electrical components and wiring are exposed while charging, recovering or purging the system;

- That there is continuity of earth bonding.

17. Repairs to sealed components.

- During repairs to sealed components, all electrical supplies shall be disconnected from the equipment being worked upon prior to any removal of sealed covers, etc. If it is absolutely necessary to have an electrical supply to equipment during servicing, then a permanently operating form of leak detection shall be located at the most critical point to warn of a potentially hazardous situation.

- Particular attention shall be paid to the following to ensure that by working on electrical components, the casing is not altered in such a way that the level of protection is affected. This shall include damage to cables, excessive number of connections, terminals not made to original specification, damage to seals, incorrect fitting of glands, etc. Ensure that apparatus is mounted securely. Ensure that seals or sealing materials have not degraded such that they no longer serve the purpose of preventing the ingress of flammable atmospheres. Replacement parts shall be in accordance with the manufacturer's specifications

Note: The use of silicon sealant may inhibit the effectiveness of some types of leak detection equipment. Intrinsically safe components do not have to be isolated prior to working on them.

18. Repair to intrinsically safe components.

Do not apply any permanent inductive or capacitance loads to the circuit without ensuring that

this will not exceed the permissible voltage and current permitted for the equipment in use. Intrinsically safe components are the only types that can be worked on while live in the presence of a flammable atmosphere. The test apparatus shall be at the correct rating. Replace components only with parts specified by the manufacturer. Other parts may result in the ignition of refrigerant in the atmosphere from a leak.

19. Cabling.

Check that cabling will not be subject to wear, corrosion, excessive pressure, vibration, sharp edges or any other adverse environmental effects. The check shall also take into account the effects of aging or continual vibration from sources such as compressors or fans.

20. Detection of flammable refrigerants.

Under no circumstances shall potential sources of ignition be used in the searching for or detection of refrigerant leaks. A halide torch (or any other detector using a naked flame) shall not be used.

21. Leak detection methods

The following leak detection methods are deemed acceptable for systems containing flammable refrigerants.

Electronic leak detectors shall be used to detect flammable refrigerants, but the sensitivity may not be adequate, or may need re-calibration. (Detection equipment shall be calibrated in a refrigerant-free area.) Ensure that the detector is not a potential source of ignition and is suitable for the refrigerant used. Leak detection equipment shall be set at a percentage of the LFL of the refrigerant and shall be calibrated to the refrigerant employed and the appropriate percentage of gas (25 % maximum) is confirmed. Leak detection fluids are suitable for use with most refrigerants but the use of detergents containing chlorine shall be avoided as the chlorine may react with the refrigerant and corrode the copper pipe-work. If a leak is suspected, all naked flames shall be removed/ extinguished. If a leakage of refrigerant is found which requires brazing, all of the refrigerant shall be recovered from the system, or isolated (by means of shut off valves) in a part of the system remote from the leak. Oxygen free nitrogen (OFN) shall then be purged through the system both before and during the brazing process.

22. Removal and evacuation.

When breaking into the refrigerant circuit to make repairs or for any other purpose conventional procedures shall be used. However, it is important that best practice is followed since inflammability is a consideration. The following procedure shall be adhered to:

- Remove refrigerant;
- Purge the circuit with inert gas;
- Evacuate;
- Purge again with inert gas;
- Open the circuit by cutting or brazing.

The refrigerant charge shall be recovered into the correct recovery cylinders. The system shall be flushed with OFN to render the unit safe. This process may need to be repeated several times. Compressed air or oxygen shall not be used for this task. Flushing shall be achieved by breaking the vacuum in the system with OFN and continuing to fill until the working pressure is achieved, then venting to atmosphere, and finally pulling down to a vacuum. This process shall be repeated until no refrigerant is within the system. When the final OFN charge is used, the system shall be vented down to atmospheric pressure to enable work to take place. This operation is absolutely vital if brazing operations on the pipe-work are to take place. Ensure that the outlet for the vacuum pump is not close to any ignition sources and there is ventilation available.

23. Decommissioning

Before carrying out this procedure, it is essential that the technician is completely familiar with the equipment and all its detail. It is recommended good practice that all refrigerants are recovered safely. Prior to the task being carried out, an oil and refrigerant sample shall be taken in case analysis is required prior to re-use of reclaimed refrigerant. It is essential that electrical power is available before the task is commenced.

- a) Become familiar with the equipment and its operation.
- b) Isolate system electrically.

c) Before attempting the procedure, ensure that:

- mechanical handling equipment is available, if required, for handling refrigerant cylinders;
- all personal protective equipment is available and being used correctly;
- the recovery process is supervised at all times by a competent person;
- recovery equipment and cylinders conform to the appropriate standards.

d) Pump down refrigerant system, if possible.

e) If a vacuum is not possible, make a manifold so that refrigerant can be removed from various parts of the system.

f) Make sure that cylinder is situated on the scales before recovery takes place.

g) Start the recovery machine and operate in accordance with manufacturer's instructions.

h) Do not overfill cylinders. (No more than 80 % volume liquid charge).

i) Do not exceed the maximum working pressure of the cylinder, even temporarily.

j) When the cylinders have been filled correctly and the process completed, make sure that the cylinders and the equipment are removed from site promptly and all isolation valves on the equipment are closed off.

k) Recovered refrigerant shall not be charged into another refrigeration system unless it has been cleaned and checked.

24. Labeling

Equipment shall be labeled stating that it has been de-commissioned and emptied of refrigerant. The label shall be dated and signed. Ensure that there are labels on the equipment stating the equipment contains flammable refrigerant.

25. Recovery

When removing refrigerant from a system, either for servicing or decommissioning, it is recommended good practice that all refrigerants are removed safely. When transferring refrigerant into cylinders, ensure that only appropriate refrigerant recovery cylinders are employed. Ensure that the correct number of cylinders for holding the total system charge are available. All cylinders to be used are designated for the recovered refrigerant and labeled for that refrigerant (i.e. Special cylinders for the recovery of refrigerant). Cylinders shall be complete with pressure-relief valve and associated shut-off valves in good working order. Empty recovery cylinders are evacuated and, if possible, cooled before recovery occurs. The recovery equipment shall be in good working order with a set of instructions concerning the equipment that is at hand and shall be suitable for the recovery of all appropriate refrigerants including, when applicable, flammable refrigerants. In addition, a set of calibrated weighing scales shall be available and in good working order. Hoses shall be complete with leak-free disconnect couplings and in good condition. Before using the recovery machine, check that it is in satisfactory working order, has been properly maintained and that any associated electrical components are sealed to prevent ignition in the event of a refrigerant release. Consult manufacturer if in doubt.

The recovered refrigerant shall be returned to the refrigerant supplier in the correct recover cylinder, and the relevant waste transfer note arranged. Do not mix refrigerants in recovery units and especially not in cylinders. If compressors or compressor oils are to be removed, ensure that they have been evacuated to an acceptable level to make certain that flammable refrigerant does not remain within the lubricant.

The evacuation process shall be carried out prior to returning the compressor to the suppliers. Only electric heating to the compressor body shall be employed to accelerate this process. When oil is drained from a system, it shall be carried out safely.

5. INSTALLATION PRECAUTIONS

Important Considerations

- The air conditioner must be installed by professional personnel and the Installation manual is used only for the professional installation personnel! The installation specifications should be subject to our after-sale service regulations.
- When filling the combustible refrigerant, any of your rude operations may cause serious injury or injuries to human body and objects.
- A leak test must be done after the installation completed.
- It is a must to do the safety inspection before maintaining or repairing an air conditioner using combustible refrigerant in order to ensure that the fire risk is reduced to minimum.
- It is necessary to operate the machine under a controlled procedure in order to ensure that any risk arising from the combustible gas or vapor during the operation is reduced to minimum.
- Requirements for the total weight of filled refrigerant and the area of a room to be equipped with an air conditioner (are shown as in the following Tables GG.1 and GG.2)

The maximum charge and the required minimum floor area

$$m_1 = (4 \text{ m}^3) \times \text{LFL}$$

$$m_2 = (26 \text{ m}^3) \times \text{LFL}$$

$$m_3 = (130 \text{ m}^3) \times \text{LFL}$$

Where LFL is the lower flammable limit in kg/ m³, R32 LFL is 0.038 kg/m³.

For the appliances with a charge amount $m_1 < M = m_2$

The maximum charge in a room shall be in accordance with the following:

$$m_{\text{max}} = 2,5 \times (\text{LFL})^{5/4} \times h_0 \times (A)^{1/2}$$

The required minimum floor area A_{min} to install an appliance with refrigerant charge M (kg) shall be in accordance with following:

$$A_{\text{min}} = (M / (2.5 \times (\text{LFL})^{5/4} \times h_0))^2$$

Table GG.1 - Maximum charge (kg)

Category	LFL (kg/m ³)	h ₀ (m)	Floor area (m ²)						
			4	7	10	15	20	30	50
R32	0.306	1	1.14	1.51	1.8	2.2	2.54	3.12	4.02
		1.8	2.05	2.71	3.24	3.97	4.58	5.61	7.254
		2.2	2.5	3.31	3.96	4.85	5.6	6.86	8.85

Table GG.2 - Minimum room area (m²)

Category	LFL (kg/m ³)	h ₀ (m)	Charge amount (M) (kg) / Minimum room area (m ²)						
			1.224kg	1.836kg	2.448kg	3.672kg	4.896kg	6.12kg	7.956kg
R32	0.306	0.6		29	51	116	206	321	543
		1		10	19	42	74	116	196
		1.8		3	6	13	23	36	60
		2.2		2	4	9	15	24	40

Installation Safety Principles

1. Site Safety



2. Operation Safety



3. Installation Safety

- Refrigerant Leak Detector
- Appropriate Installation Location

Please note that:

- The installation site should be well-ventilated.
- The sites for installing and maintaining an air conditioner using Refrigerant R32 should be free from open fire or welding, smoking, drying oven or any other heat source higher than 548 which easily produces open fire.
- When installing an air conditioner, it is necessary to take appropriate anti-static measures such as wear anti-static clothing and/or gloves.
- It is necessary to choose the site convenient for installation or maintenance wherein the air inlets and outlets of the indoor and outdoor units should be not surrounded by obstacles or close to any heat source or combustible and/or explosive environment.
- If the indoor unit suffers refrigerant leak during the installation, it is necessary to immediately turn off the valve of the outdoor unit and all the personnel should go out till the refrigerant leaks completely for 15 minutes. If the product is damaged, it is a must to carry such damaged product back to the maintenance station and it is prohibited to weld the refrigerant pipe or conduct other operations on the user's site.
- It is necessary to choose the place where the inlet and outlet air of the indoor unit is even.

- It is necessary to avoid the places where there are other electrical products, power switch plugs and sockets, kitchen cabinet, bed, sofa and other valuables right under the lines on two sides of the indoor unit.

Suggested Tools

Tool	Picture	Tool	Picture
Standard Wrench		Level	
Adjustable/ Crescent Wrench		Flaring tool	
Torque Wrench		Clamp on Amp Meter	
Hex Keys or Allen Wrenches		Vacuum Pump	
Drill & Drill Bits		Safety Glasses	
Hole Saw		Work Gloves	
Pipe Cutter		Refrigerant Scale	
Screw drivers (Phillips & Flat blade)		Micron Gauge	
Manifold and Gauges			

Pipe Length and Additional Refrigerant

Inverter Models Capacity (Btu/h)	9K-12K
Length of pipe with standard charge	5m/16ft
Maximum distance between indoor and outdoor unit	15m/49ft
Additional refrigerant charge	15g/m
Max. diff. in level between indoor and outdoor unit	10m/32ft
Type of refrigerant	R32

Torque Parameters

PIPE Size	Newton meter [N x m]	Pound-force foot (lbf-ft)	Kilogram-force meter (kgf-m)
1/4" (Φ 6.35)	18 - 20	24.4 - 27.1	2.4 - 2.7
3/8" (Φ 9.52)	30 - 35	40.6 - 47.4	4.1 - 4.8
1/2" (Φ 12)	45 - 50	61.0 - 67.7	6.2 - 6.9
5/8" (Φ 15.88)	60 - 65	81.3 - 88.1	8.2 - 8.9

Dedicated Distribution Device and Wire for Air Conditioner

Maximum Operating Current of Air Conditioner (A)	Minimum Wire Cross-sectional 2 Area(mm ²)	Specification of Socket or Switch (A)	Fuse Specification (A)
≤8	0.75	10	20
>8 and ≤10	1.0	10	20
>10 and ≤15	1.5	16	32
>15 and ≤24	2.5	25	32
>24 and ≤28	4.0	32	64
>28 and ≤32	4.6	40	64

Note: This table is only for reference, the installation shall meet the requirements of local laws and regulations.

6. INDOOR UNIT INSTALLATION

Step1: Select Installation location

- 1.1 Ensure the installation complies with the installation minimum dimensions (defined below) and meets the minimum and maximum connecting piping length and maximum change in elevation as defined in the System Requirements section.
- 1.2 Air inlet and outlet will be clear of obstructions, ensuring proper airflow throughout the room.
- 1.3 Condensate can be easily and safely drained.
- 1.4 All connections can be easily made to outdoor unit.
- 1.5 Indoor unit is out of reach of children.
- 1.6 A mounting wall strong enough to withstand four times the full weight and vibration of the unit.
- 1.7 Filter can be easily accessed for cleaning.
- 1.8 Leave enough free space to allow access for routine maintenance.
- 1.9 Install at least 10 ft. (3 m) away from the antenna of TV set or radio. Operation of the air conditioner may interfere with radio or TV reception in areas where reception is weak. An amplifier may be required for the affected device.
- 1.10 Do not install in a laundry room or by a swimming pool due to the corrosive environment.
- 1.11 For ETL certification area, Caution: Mount with the lowest moving parts at least 8 ft. (2.4 m) above floor or grade level.

Minimum Indoor Clearances

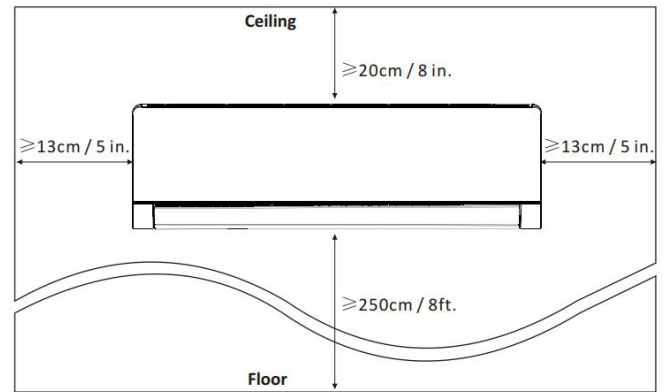

Step2: Install Mounting Plate

- 2.1 Take the mounting plate from the back of indoor unit.
- 2.2 Ensure to meet the minimum installation dimension requirements as step 1, according to the size of mounting plate, determine the position and stick the mounting plate close to the wall.
- 2.3 Adjust the mounting plate to a horizontal state with a spirit level, then mark out the screw hole positions on the wall.
- 2.4 Put down the mounting plate and drill holes in the marked positions with drill.
- 2.5 Insert expansion rubber plugs into the holes, then hang the mounting plate and fix it with screws.

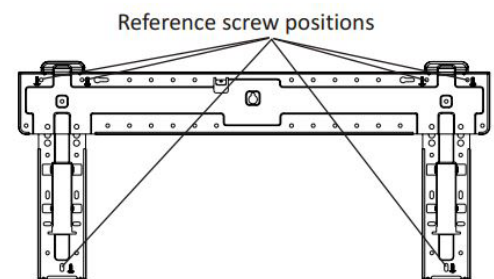
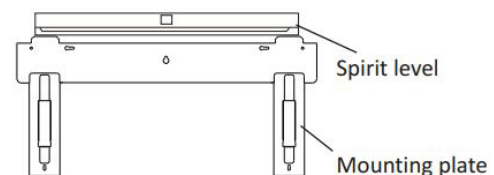

Note:

- (I) Make sure the mounting plate is firm enough and flat against the wall after installation.
- (II) This figure shown may be different from the actual object, please take the latter as the standard.

Step3: Drill Wall Hole

- 3.1 Three optional piping modes show be determined

Mode1: Left, the Fresh air pipe, the refrigerant piping, the drainage pipe, and connecting cables all are through one hole to the outside.

Mode2: Right, the Fresh air pipe, the refrigerant piping, the drainage pipe, and connecting cables all are through one hole to the outside

Mode3: Back, the Fresh air pipe need a single hole, and the others need another hole

3.2 For Mode3, follow the reference size for mounting plate and hole to determine location.

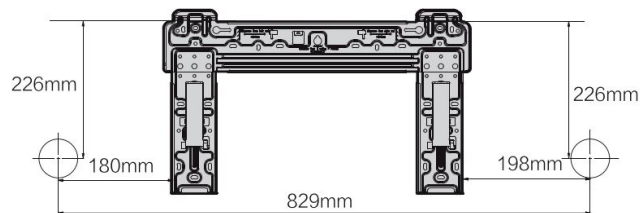

For Mode1 and Mode2, Determine the location of wall hole base on the following size.

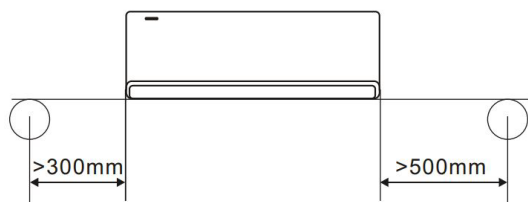

3.3 For mode1 and mode2, the hole should have a 83mm diameter at least and a small oblique angle to facilitate drainage.

For mode3, the two holes should have 70mm diameter at least and a small oblique angle to facilitate drainage.

3.4 Drill the wall hole with suitable core drill and with small oblique angle lower than the indoor end about 5mm to 10mm.

3.5 Place the wall sleeve and wall sleeve cover(both are optional parts) to protect the connection parts.

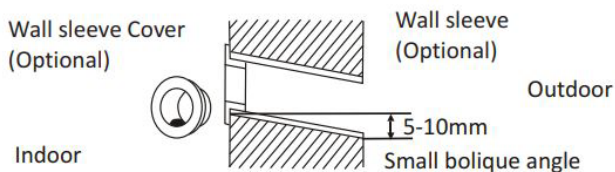

Caution:

When drill the wall hole, make sure to avoid wires, plumbing and other sensitive components.

Step4: Connecting Refrigerant Pipe

4.1 According to the wall hole position, select the appropriate piping mode. There are three optional piping modes for indoor units as shown in the figure below: In Piping Mode 1 or Piping Mode 3, a notch should be made by using scissors to cut the plastic sheet of piping outlet and cable outlet on the corresponding side of the indoor unit.

Note: When cutting off the plastic sheet at the outlet, the cut should be trimmed to smooth.

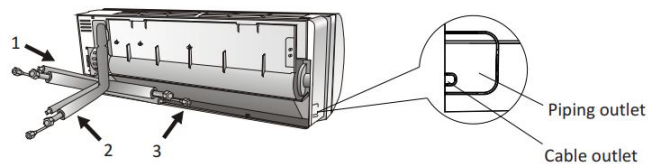

4.2 Bending the connecting pipes with the port facing up as shown in the figure.

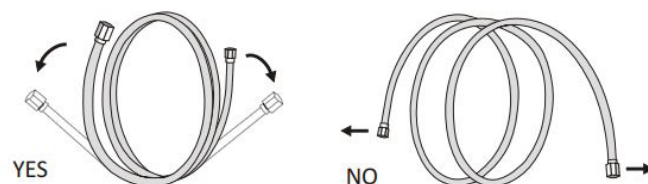

4.3 Take off the plastic cover in the pipe ports and take off the protective cover on the end of piping connectors.

4.4 Check whether there is any sundry on the port of the connecting pipe and make ensure the port is clean.

4.5 After align the center, rotate the nut of the connecting pipe to tighten the nut as tightly as possible by hand.

4.6 Use a torque wrench to tighten it according to the torque values in the torque requirements table; (Refer to the torque requirements table on section INSTALLATION PRECAUTIONS)

4.7 Wrap the joint with the insulation pipe.

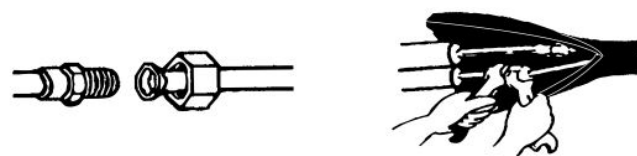

Note:

For R32 refrigerant, the connector should be placed outdoors

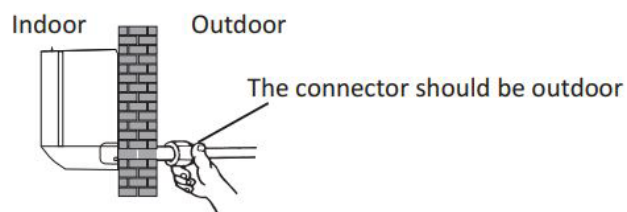

Step5: Connect Drainage Hose

5.1 Adjust the drainage hose(if applicable) In some model, both sides of the indoor unit are provided with drainage ports, you can choose one of them to attach the drainage hose. And plug the unused drain port with the rubber attached in one of the ports.

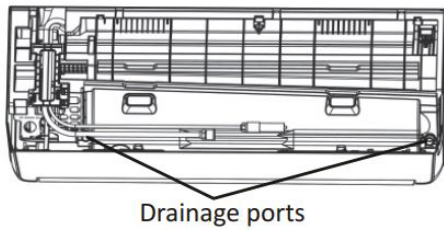

- 5.2 Connect the drainage hose to the drainage port, ensure the joint is firm and the sealing effect is good.
- 5.3 Wrap the joint firmly with teflon tape to ensure no leaks.

Note: Make sure there is no twists or dents, and the pipes should be placed obliquely downward to avoid blockage, to ensure proper drainage.

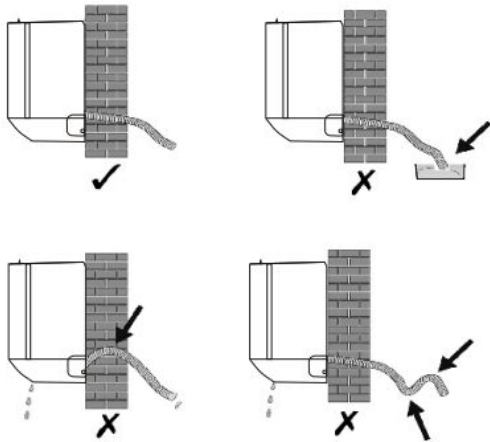

Step6: Connect Wiring

- 6.1 Choose the right cables size determined by the maximum operating current on the nameplate. (Check the cables size refer to section INSTALLATION PRECAUTIONS)
- 6.2 Open the front panel of indoor unit.
- 6.3 Use a screwdriver, open the electric control box cover, to reveal the terminal block.
- 6.4 Unscrew the cable clamp.
- 6.5 Insert one end of the cable into the position of control box from the back of the right end of the indoor unit.
- 6.6 Connect the wires to corresponding terminal according to the wiring diagram on the electric control box cover. And make sure that they are well connected.
- 7.1
- 6.7 Screw the cable clamp to fasten the cables.
- 6.8 Reinstall the electric control box cover and front panel.

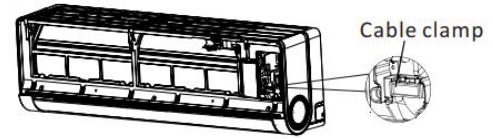
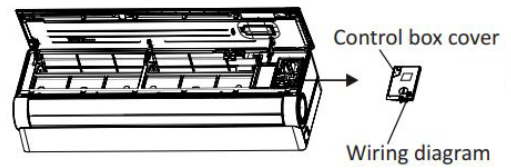

Step7: Connecting Fresh Air Pipe and place the filter

- 7.1 According to the wall hole position, select the appropriate piping mode.

Model1: Left, together with refrigerant piping ,the drainage pipe, and connecting cables.

Model2: Right, together with refrigerant piping, the drainage pipe, and connecting cables.

Model3: Back, single hole for fresh air pipe.

- 7.2 Determine the pipe length. According to the installation environment, determine to adjust the length of fresh air pipe.

7.2.1 Shorten the length

Just cut one side of the pipe to your desired length

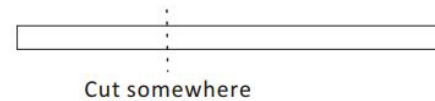

7.2.2 Increase the length

As the desire length, determine to cut the pipe connected with the connector or not, then take another pipe, follow the picture to connect the two pipes and use a tape to tighten the joint.

No cut, just connect two pipes by contrarotate them into the straight connector

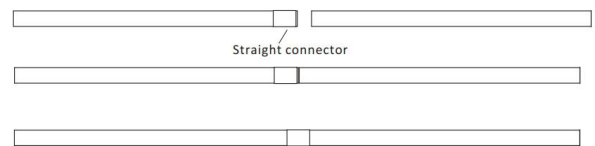

Cut one pipe as 7.2.1, then connect the two pipes

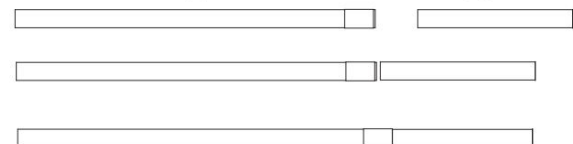

- 7.3 Tighten(contrarotate) the fresh air pipe into the fresh air hole at the back of the indoor unit.

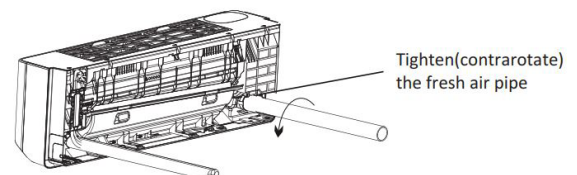

- 7.4** Open the indoor panel and take out the filter holder, place HEPA filter for fresh air then restore the holder.

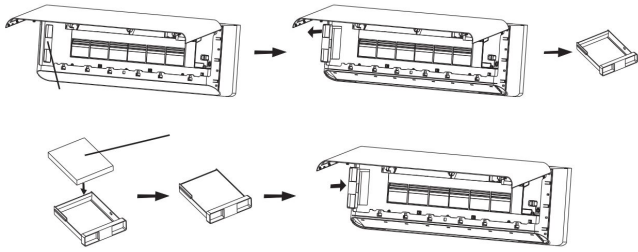

Step8: Wrap Piping and Cable

After the refrigerant pipes, connecting wires and drainage hose are all installed, in order to save space, protect and insulate them, it must be bundle with insulating tape before passing them through the wall hole.

- 8.1** Arrange the pipes ,cables and drainage hose well as the following picture.

Model1

After arrange all pipes and cables, take the Metal strap supporter out of the accessories of fresh air. Insert into the slot as the picture to fix the pipes.

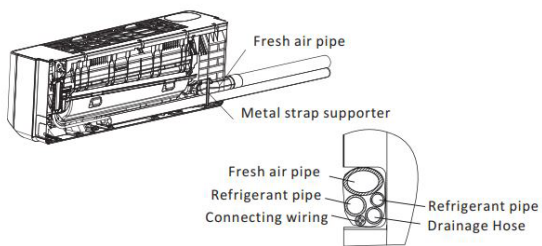

Model2

After arrange all pipes and cables, take the Metal strap supporter out of the accessories of fresh air. Insert into the slot as the picture to fix the pipes.

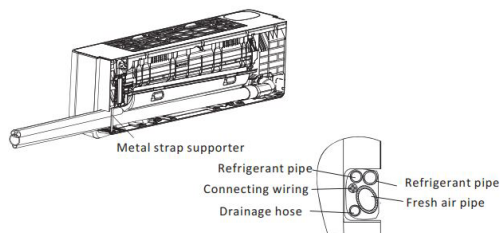

Model3

After arrange all pipes and cables, take the Metal strap supporter out of the accessories of fresh air. Insert into the slot as the picture to fix the pipes.

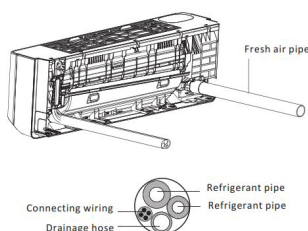

Note:

- Make sure the drainage pipe is at the bottom.
- Avoid crossing and bending of parts.

- 8.2** Using the insulating tape wrap the fresh air pipes, the refrigerant pipes, connecting wires and drainage hose together tightly.

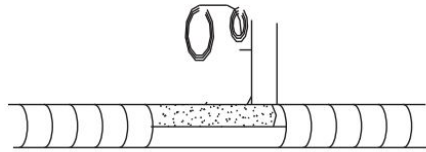

Step9: Mount Indoor Unit

- 9.1** Slowly pass the refrigerant pipes, connecting wires and drainage hose wrapped bundle through the wall hole.
- 9.2** Hook the top of indoor unit on the mounting plate.
- 9.3** Apply slight pressure to the left and right sides of the indoor unit, make sure the indoor unit is hooked firmly.
- 9.4** Push down the bottom of indoor unit to let the snaps onto the hooks of the mounting plate, and make sure it is hooked firmly

Step10: Place the protection cover for Fresh air inlet

Take out the protection cover and rotate it into the fresh air pipe, use tape to tighten the joint. And keep the cover facing to the ground to prevent the rain flow into the fresh air pipe. Make sure the fresh air inlet is over 200mm from the wall or other blocks.

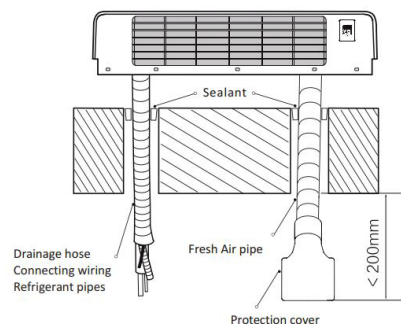

7. OUTDOOR UNIT INSTALLATION

Step1: Select Installation Location

Select a site that allows for the following:

- 1.1** Do not install the outdoor unit near sources of heat, steam or flammable gas.
- 1.2** Do not install the unit in too windy or dusty places.
- 1.3** Do not install the unit where people often pass. Select a place where the air discharge and operating sound will not disturb the neighbors.
- 1.4** Avoid installing the unit where it will be exposed to direct sunlight (other wise use a protection, if necessary, that should not interfere with the air flow).

- 1.5 Reserve the spaces as shown in the picture for the air to circulate freely.
- 1.6 Install the outdoor unit in a safe and solid place.
- 1.7 If the outdoor unit is subject to vibration, place rubber blankets onto the feet of the unit.

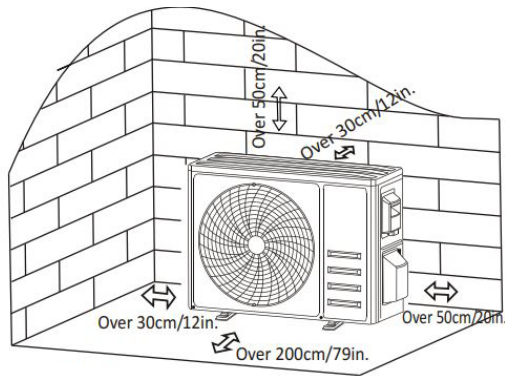

Step2: Install Drainage Hose

- 2.1 This step only for heat pump models or RCACs.
- 2.2 Insert the drainage joint to the hole at the bottom of the outdoor unit.
- 2.3 Connect the drainage hose to the joint and make the connection well enough.

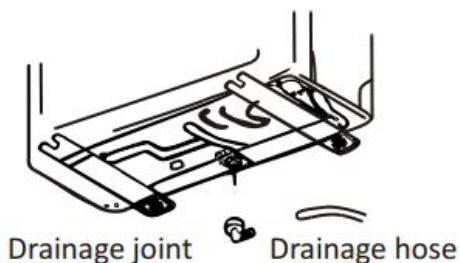

Step3: Fix Outdoor Unit

- 3.1 According to the outdoor unit installation dimensions to mark the installation position for expansion bolts.
- 3.2 Drill holes and clean the concrete dust and place the bolts .
- 3.3 If applicable install 4 rubber blankets on the hole before place the outdoor unit (Optional). This will reduce vibrations and noise.
- 3.4 Place the outdoor unit base on the bolts and pre-drilled holes.
- 3.5 Use wrench to fix the outdoor unit firmly with bolts.

Note:

The outdoor unit can be fixed on a wall-mounting bracket. Follow the instruction of the wall-mounting bracket to fix the wall-mounting bracket on the wall, and then fasten the outdoor unit on it and keep it horizontal. The wall-mounting bracket must be able to support at least 4 times of the weight of outdoor unit.

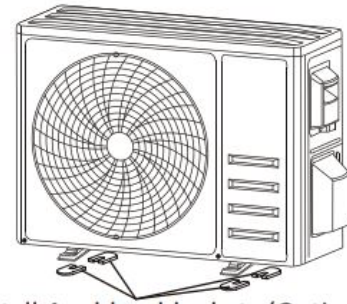

Install 4 rubber blankets (Optional)

Step4: Install Wiring

- 4.1 Use a phillips screwdriver to unscrew wiring cover, grasp and press it down gently to take it down.
- 4.2 Unscrew the cable clamp and take it down.
- 4.3 According to the wiring diagram pasted inside the wiring cover, connect the connecting wires to the corresponding terminals, and ensure all connections are firmly and securely.
- 4.4 Reinstall the cable clamp and wiring cover.

Note: When connecting the wires of indoor and outdoor units, the power should be cut off.

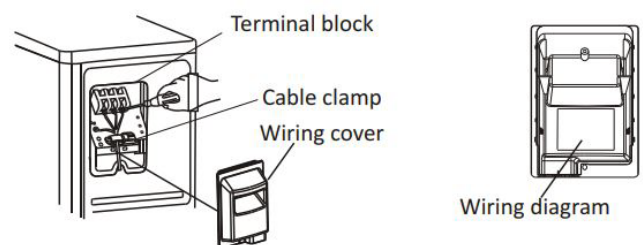

Step5: Connecting Refrigerant Pipe

- 5.1 Unscrews the valve cover, grasp and press it down gently to take it down(if the valve cover is applicable).
- 5.2 Remove the protective caps from the end of valves.
- 5.3 Take of the plastic cover in the pipe ports and check whether there is any sundry on the port of the connecting pipe and make ensure the port is clean.
- 5.4 After aligning the center, rotate the flare nut of the connecting pipe to tighten the nut as tightly as possible by hand.
- 5.5 Use a spanner to hold the body of the valve and use a torque wrench to tighten the flare nut according to the torque values in the torque requirements table. (Refer to the torque requirements table on section INSTALLATION PRECAUTIONS)

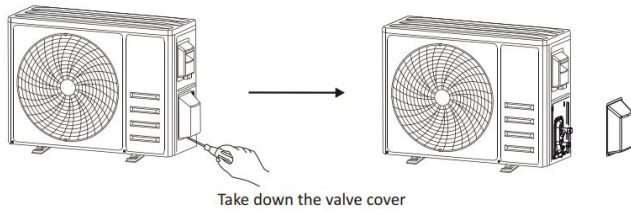

connection pipes

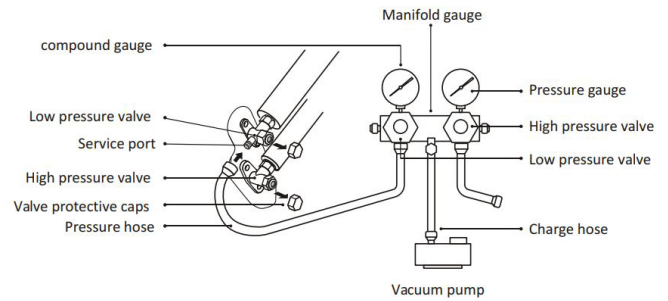
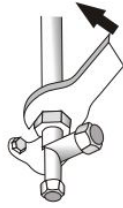
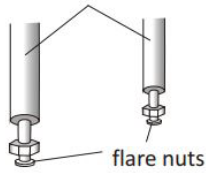

8. TEST OPERATION

Inspections Before Test Run

Do the following checks before test run.

Step6: Vacuum Pumping

- 6.1 Use a spanner to take down the protective caps from the service port, low pressure valve and high pressure valve of the outdoor unit.
- 6.2 Connect the pressure hose of manifold gauge to the service port on the outdoor unit low pressure valve.
- 6.3 Connect the charge hose from the manifold gauge to the vacuum pump.
- 6.4 Open the low pressure valve of the manifold gauge and close the high pressure valve.
- 6.5 Turn on the vacuum pump to vacuum the system.
- 6.6 The vacuum time should not be less than 15 minutes, or make sure the compound gauge indicates -0.1 MPa (-76 cmHg)
- 6.7 Close the low pressure valve of the manifold gauge and turn off the vacuum.
- 6.8 Hold the pressure for 5 minutes, make sure that the rebound of compound gauge pointer does not exceed 0.005 MPa .
- 6.9 Open the low pressure valve counterclockwise for $1/4$ turn with hexagonal wrench to let a little refrigerant fill in the system, and close the low pressure valve after 5 seconds and quickly remove the pressure hose.
- 6.10 Check all indoor and outdoor joints for leakage with soapy water or leak detector.
- 6.11 Fully open the low pressure valve and high pressure valve of the outdoor unit with hexagonal wrench.
- 6.12 Reinstall the protective caps of the service port, low pressure valve and high pressure valve of the outdoor unit.
- 6.13 Reinstall the valve cover.

DESCRIPTION	INSPECTION METHOD
Electrical safety inspection	<ul style="list-style-type: none"> • Check whether the power supply voltage complies with specification. • Check whether there is any wrong or missing connection between the power lines, signal line and earth wires. • Check whether the earth resistance and insulation resistance comply with requirements.
Installation safety inspection	<ul style="list-style-type: none"> • Confirm the direction and smoothness of drainage pipe. • Confirm that the joint of refrigerant pipe is installed completely. • Confirm the safety of outdoor unit, mounting plate and indoor unit installation. • Confirm that the valves are fully open. • Confirm that there are no foreign objects or tools left inside the unit. • Complete installation of indoor unit air inlet grille and panel.
Refrigerant leakage detection	<ul style="list-style-type: none"> • The piping joint, the connector of the two valves of the outdoor unit, the valve spool, the welding port, etc., where leakage may occur. • Foam detection method: Apply soapy water or foam evenly on the parts where leakage may occur, and observe whether bubbles appear or not, if not, it indicates that the leakage detection result is safe. • Leak detector method: Use a professional leak detector and read the instruction of operation, detect at the position where leakage may occur. • The duration of leak detection for each position should last for 3 minutes or more; If the test result shows that there is leakage, the nut should be tightened and tested again until there is no leakage; After the leak detection is completed, wrap the exposed pipe connector of indoor unit with thermal insulation material and wrap with insulation tape.

Test Run Instruction



1. Turn on the power supply.
2. Press the ON/OFF button on the remote controller to turn on the air conditioner.
3. Press the Mode button to switch the mode COOLING and HEATING.
In each mode set as below:
COOLING-Set the lowest temperature
HEATING-Set the highest temperature
4. Run about 8 minutes in each mode and check all functions are properly run and respond the remote controller. Functions check as recommended:
 - 4.1 If the outlet air temperature responds to the cooling and heating modes
 - 4.2 If the water drains properly from the drainage hose
 - 4.3 If the Louver and deflectors(optional) rotate properly
5. Observe the test run state of the air conditioner at least 30 minutes.
6. After the successfully test run, return the normal setting and press ON/OFF button on the remote controller to turn off the unit.
7. Inform the user to read this manual carefully before use, and demonstrate to the user how to use the air conditioner, the necessary knowledge for service and maintenance, and the reminder for storage of accessories.

Note:

If the ambient temperature exceeds the range mentioned in the section OPERATION INSTRUCTIONS, and it can not run COOLING or HEATING mode, lift the front panel and refer to the emergency button operation to run the COOLING and HEATING mode.

9. MAINTENANCE

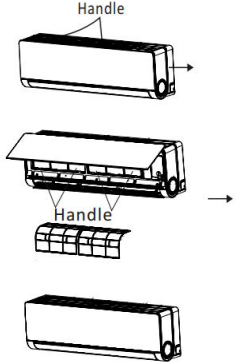
Warning	<ul style="list-style-type: none"> • When cleaning, you must shut down the machine and cut off the power supply for more than 5 minutes. • Under no circumstances should the air conditioner be flushed with water. • Volatile liquid (e.g. thinner or gasoline) will damage the air conditioner, so only use soft dry cloth or wet cloth dipped with neutral detergent to clean the air conditioner. • Pay attention to cleaning the filter screen regularly to avoid dust covering which will affect the filter screen effect. When the operating environment is dusty, the cleaning frequency should be increased appropriately. • After removing the filter screen, do not touch the fins of the indoor unit to avoid scratching.
----------------	------------------------------------------------------------------------------------------------------------------------------------------------------------------------------------------------------------------------------------------------------------------------------------------------------------------------------------------------------------------------------------------------------------------------------------------------------------------------------------------------------------------------------------------------------------------------------------------------------------------------------------------------------------------------------------------------------------------------------------------------------------------------------------------

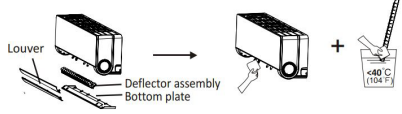
Clean the unit	 <p>Wring it dry and gently wipe the surface of the unit. Tip: Wipe frequently to keep air conditioner clean and good appearance.</p>
Disassembly and assembly of filter	<ul style="list-style-type: none"> • Grasp the raised handle on the filter by hand, and then pull the filter out in the direction deviating from the unit, so that the upper edge of the filter is separated from the unit. The filter can be removed by lifting the filter upwards. • When installing the filter, first insert the lower end of the filter screen into the corresponding position of the unit, and then squeeze the upper end of the filter into the corresponding buckling position of the unit body. 
Clean the filter	 <p>Take out the filter from the unit Clean the filter with soapy water and air dry it Replace the filter</p> <p>Tip: When you find accumulated dust in the filter, please clean the filter in time to ensure the clean, healthy and efficient operation inside the air conditioner</p>
Cleaning of inner air duct	<ul style="list-style-type: none"> • First, loosen the knob on the middle of louver and bend the louver outwards to take it out. • Then, grasp both sides of bottom plate push downwards to take down the bottom plate. • Finally, loosen the buckle of deflector assembly with your thumb and take it out. • Wipe the air duct and fan assembly with a clean and wrung wet rag. • Clean the removed parts with soapy water and air dry it. • After cleaning, restore the removed parts in turn. 

Service and maintenance	<ul style="list-style-type: none"> • When the air conditioner is not in use for a long time, do the following work: Take out the batteries of the remote controller and disconnect the power supply of the air conditioner. • When starting to use after long-term shutdown: <ol style="list-style-type: none"> 1. Clean the unit and filter screen; 2. Check whether there are obstacles at the air inlet and outlet of indoor and outdoor units; 3. Check whether the drain pipe is unobstructed; Install the batteries of the remote controller and check whether the power is on.
--------------------------------	-------------------------------------------------------------------------------------------------------------------------------------------------------------------------------------------------------------------------------------------------------------------------------------------------------------------------------------------------------------------------------------------------------------------------------------------------------------------------------------------------------------------------------------------------------------------------------------------------------------------------------------------------

10. TROUBLESHOOTING

MALFUNCTION	POSSIBLE CAUSES
The appliance does not operate	<ul style="list-style-type: none"> • Power failure/plug pulled out. • Damaged indoor/outdoor unit fan motor. • Faulty compressor thermomagnetic circuit breaker. • Faulty protective device or fuses. • Loose connections or plug pulled out. • It sometimes stops operating to protect the appliance. • Voltage higher or lower than the voltage range. • Active TIMER-ON function. • Damaged electronic control board.
Strange odor	<ul style="list-style-type: none"> • Dirty air filter
Noise of running water	<ul style="list-style-type: none"> • Back flow of liquid in the refrigerant circulation.
A fine mist comes from the air outlet	<ul style="list-style-type: none"> • This occurs when the air in the room becomes very cold, for example in the COOLING or DEHUMIDIFYING/ DRY modes.
A strange noise can be heard	<ul style="list-style-type: none"> • This noise is made by the expansion or contraction of the front panel due to variations in temperature and does not indicate a problem.
Insufficient airflow, either hot or cold	<ul style="list-style-type: none"> • Unsuitable temperature setting. • Obstructed air conditioner intakes and outlets. • Dirty air filter. • Fan speed set at minimum. • Other sources of heat in the room. • No refrigerant.
The appliance does not respond to commands	<ul style="list-style-type: none"> • Remote control is not close enough to indoor unit. • The batteries of remote control need to be replaced. • Obstacles between remote control and signal receiver in indoor unit.
The display is off	<ul style="list-style-type: none"> • Active DISPLAY function. • Power failure
Switch off the air conditioner immediately and cut off the power supply in the event of:	<ul style="list-style-type: none"> • Strange noises during operation. • Faulty electronic control board. • Faulty fuses or switches. • Spraying water or objects inside the appliance. • Overheated cables or plugs. • Very strong smells coming from the appliance.

Error code on the display

In case of error, the display on the indoor unit shown the following error codes:

DISPLAY	DESCRIPTION OF THE TROUBLE
E1	Indoor room temperature sensor fault
E2	Indoor pipe temperature sensor fault
E3	Outdoor pipe temperature sensor fault
E4	Refrigerant system leakage or fault
E6	Malfunction of indoor fan motor
E7	Outdoor ambient temperature sensor fault
E0	Indoor and outdoor communication fault
E8	Outdoor discharge temperature sensor fault
E9	Outdoor IPM module fault
EA	Outdoor current detect fault
EE	Outdoor PCB EEPROM fault
EF	Outdoor fan motor fault
EH	Outdoor suction temperature sensor fault
CL	Filter cleaning reminder

DISPOSAL GUIDELINE (European)

This appliance contains refrigerant and other potentially hazardous materials. When disposing of this appliance, the law requires special collection and treatment. DO NOT dispose of this product as household waste or unsorted municipal waste.

When disposing of this appliance, you have the following options:

- Dispose of the appliance at designated municipal electronic waste collection facility.
- When buying a new appliance, the retailer will take back the old appliance free of charge.
- The manufacturer will also take back the old appliance free of charge.
- Sell the appliance to certified scrap metal dealers.
- Disposing of this appliance in the forest or other natural surroundings endangers your health and is bad for the environment. Hazardous substances may leak into the ground water and enter the food chain.

11. REMOTE CONTROL

Remote control DISPLAY



SYMBOLS	MEANING
	Battery indicator
	Auto Mode
	Cooling Mode
	Dry Mode
	Fan only Mode
	Heating Mode
	ECO Mode
	Timer
	Temperature indicator
	Fan speed: Auto/ low/ low-mid/ mid/ mid-high/ high
	Mute function
	TURBO function
	Up-down auto swing
	Left-right auto swing
	SLEEP function
	Health function

SYMBOLS	MEANING
	I FEEL function
	8°C heating function
	Signal indicator
	Gentle wind
	Child-Lock
	Display ON/OFF
	GEN function
	Self-Clean function
	Anti-Mildew
	Fresh air

The display and some functions of the remote control may vary according to the model.

BUTTON	FUNCTION
	To turn on/off the air conditioner
	To increase temperature, or Timer setting hours
	To decrease temperature, or Timer setting hours
MODE	To select the mode of operation (AUTO, COOL, DRY, FAN, HEAT)
ECO	To activate/deactivate the ECO function Long press to activate/deactivate the 8 heating function (depending on models)
TURBO	To activate/deactivate the TURBO function.
FAN	To select the fan speed of auto/mute/ low/low-mid/mid/mid-high/high/turbo
TIMER	To set the time for timer on/off
SLEEP	To switch-on/off the function SLEEP
DISPLAY	To switch-on/off the LED display
	To stop or start horizontal flaps louver movement or set the desired up/ down air flow direction
	To stop or start vertical deflectors louver movement or set the desired left/right air flow direction
I FEEL	To switch-on/off the I FEEL function
MUTE	To switch-on/off the MUTE function Long press to activate/deactivate the GEN function (depending on models)
MODE + TIMER	To activate/deactivate the CHILD-LOCK function.

BUTTON	FUNCTION
GENTLE WIND	To activate/deactivate the GENTLE WIND function (depending on models)
HEALTH	To activate/deactivate the HEALTH function (depending on models)
	To activate/deactivate the SELF-CLEAN function when switch OFF
FRESH AIR	To activate/deactivate the Fresh Air function and select the fan speed

The display and some functions of the remote control may vary according to the model.

The shape and position of buttons and indicators may vary according to the model, but their function is the same.

The unit confirms the correct reception of each button with the beep.

Replacement of Batteries

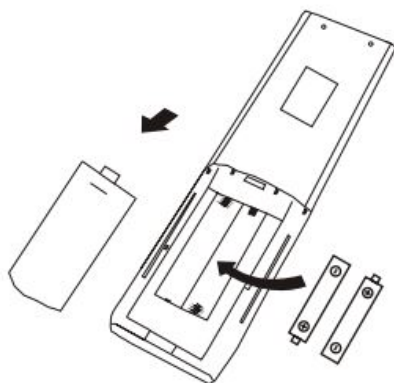

Remove the battery cover plate from the rear of the remote control, by sliding it in direction as the arrow. Install the batteries according the direction (+and-) shown on the Remote Control.

Reinstall the battery cover by sliding it into place.

Use 2 pieces LRO3 AAA (1.5V) batteries. Do not use rechargeable batteries. Replace the old batteries with new ones of the same type when the display is no longer legible. Do not dispose batteries as unsorted municipal waste. Collection of such waste separately for special treatment is necessary.

For some models of the remote controller, you can program the temperature display between °C and °F

1. Press and hold the **TURBO** button over 5 seconds to get into the change mode.
2. Press and hold the **TURBO** button, until it switch to °C and °F.

3. Then release the pressing and wait for 5 seconds, the function will be selected.

Note:

1. Direct the remote control toward the Air conditioner.
2. Check that there are no objects between the remote control and the Signal receptor in the indoor unit.
3. Never leave the remote control exposed to the rays of the sun.
4. Keep the remote control at a distance of at least 1m from the television or other electrical appliances.

COOLING MODE

COOL ❄️ The cooling function allows the air conditioner to cool the room and reduce Air humidity at the same time

To activate the cooling function (COOL), press the **MODE** button until the symbol ❄️ appears on the display. With the button ^ or v set a temperature lower than that of the room.

HEATING MODE

HEAT ☀️ The heating function allows the air conditioner to heat the room

To activate the heating function (HEAT), press the **MODE** button until the symbol ☀️ appears on the display. With the button ^ or v set a temperature higher than that of the room.

- In HEATING operation, the appliance can automatically activate a defrost cycle, which is essential to clean the frost on the condenser so as to recover its heat exchange function. This procedure usually lasts for 2-10 minutes. During defrosting, indoor unit fan stop operation. After defrosting, it resumes to HEATING mode automatically.

- (For North American market) If necessary, you can press ECO button 10 times within 8 seconds under heating mode to start the forced defrosting. It will defrost the outdoor ice much faster

FAN MODE (Not FAN button)

FAN 🌀 Fan mode, air ventilation only.

To set the FAN mode, press **MODE** until 🌀 appears on the display.

DRY MODE

DRY 

This function reduces the humidity of the air to make the room more comfortable.

To set the DRY mode, Press **MODE** until  appears in the display. An automatic function of pre-setting is activated.

FAN SPEED function (FAN button)

FAN 

Change the operating fan speed.

Press **FAN** button to set the running fan speed, it can be set to AUTO/ MUTE/ LOW/ LOW-MID / MID/ MID-HIGH/ HIGH/ TURBO speed circularly

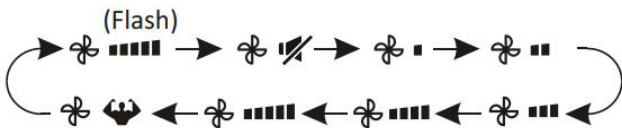

CHILD-LOCK FUNCTION

- Long press **MODE** and **TIMER** button together to active this function, and do it again to deactivate this function.
- Under this function, no single button will active.

TIMER function ---- TIMER ON

TIMER 

To automatically switch on the appliance.

When the unit is switch-off, you can set the TIMER ON.

To set the time of automatic switch-on as below:

1. Press **TIMER** button first time to set the switch-on,  and **[60h]** will appear on the remote display and flashes.
2. Press **^** or **v** to button to set desired Timer-on time. Each time you press the button, the time increases/decreases by half an hour between 0 and 10 hours and by one between 10 and 24 hours.
3. Press **TIMER** button second time to confirm.
4. After Timer-on setting, set the needed mode (Cool/ Heat/ Auto/ Fan/ Dry), by press the **MODE** button. And set the needed fan speed, by press **FAN** button. And press **^** or **v** to set the needed operation temperature.

CANCEL it by press TIMER button.

TIMER FUNCTION ---- TIMER OFF

TIMER 

To automatically switch off the appliance

When the unit is switch-on, you can set the **TIMER OFF**.

To set the time of automatic switch-off, as below:







1. Confirm the appliance is ON.
2. Press the **TIMER** button at first time to set the switch-off. Press **^** or **v** to set the needed timer.
3. Press **TIMER** button at the second time to confirm.

CANCEL it by press TIMER button.

Note: All programming should be operated within 5 seconds, otherwise the setting will be cancelled.

SWING FUNCTION



1. Press the button **SWING** to activate the louver
 - Press  to activate the horizontal flaps to swing from up to down, the  will appear on the remote display.
 - Press  to active the vertical deflectors to swing from left to right, the  will appear on the remote display.
 - Do it again to stop the swing movement at the current angle.
2. If the vertical deflectors are positioned manually which placed under the flaps, they allow to move the air flow direct to rightward or leftward.
3. Long press  or  over 3 seconds to select more angles of the airflow direction.

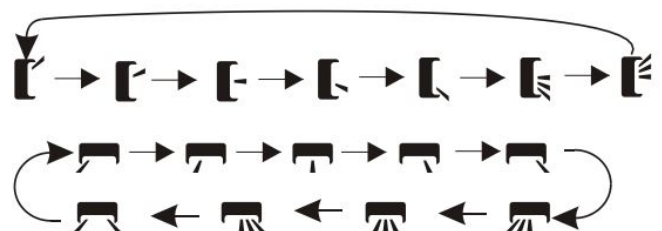

Never position Flaps manually, the delicate mechanism might get seriously damaged!

Never put fingers, sticks or other objects into the air inlet or outlet vents. Such accidental contact with live parts might cause unforeseeable damage or injury.

TURBO FUNCTION

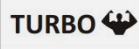

To activate turbo function, press the **TURBO** button, and  will appear on the display. Press again to cancel this function. In COOL/ HEAT mode, when you select TURBO feature, the appliance will turn to quick COOL or quick HEAT mode, and operate the highest fan speed to blow strong airflow.

MUTE FUNCTION

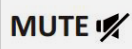

1. Press **MUTE** button to active this function, and  will appears on the remote display. Do it again to deactivate this function.
2. When the MUTE function runs, the remote controller will display the auto fan speed, and the indoor unit will operate at lowest fan speed to help experience a quiet feeling.
3. When press FAN/ TURBO button, the **MUTE** function will be cancel. MUTE function can not be activated under dry mode.

ECO FUNCTION

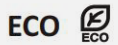

In this mode the appliance automatically sets the operation to save energy.

Press the **ECO** button, the  appears on the display, and the appliance will run in ECO mode. Press again to cancel it.

Note: The ECO function is available in both COOLING and HEATING modes.

SLEEP FUNCTION



Pre-setting automatic operating program.

Press **SLEEP** button to activate the **SLEEP** function, and  appears on the display. Press again to cancel this function.

After 10 hours running in sleep mode, the air conditioner will change to the previously set mode.

DISPLAY FUNCTION (Indoor display)



Switch ON/OFF the LED display on panel.

Press **DISPLAY** button to switch off the LED display on the panel. Press again to switch on the LED display.

I FEEL FUNCTION (Optional)



Press **I FEEL** button to active the function, the  will appear on the remote display. Do it again to deactivate this function.

This function enables the remote control to measure the temperature at its current location, and send this signal to the air conditioner to optimize the temperature around you and ensure the comfort. It will automatically deactivate 2 hours later.

GEN FUNCTION (Optional)



1. Turn on the indoor unit at first, and long press **MUTE** button 3 seconds to activate, and do it again to deactivate this function.
2. Under this function, short press **MUTE** button to select the General type L3 - L2 - L1 - OF.
3. Select OF and wait 2 seconds to exit it.
* If the indoor unit displays "OA", please use the remote to raise the operating gear of the GEN mode, and the compressor will restart after stopping for 3 minutes

SELF-CLEAN FUNCTION (Optional)

To active this function, turn off the indoor unit at first, then press **HEALTH** button then you will hear a beep, **AC** will appear on the indoor LED, and  will appear on the remote display .

1. This function helps carry away the accumulated dirt, bacteria, etc from the indoor evaporator.
2. This function will run about 30 minutes, and it will return to the pre-setting mode. You can press  button to cancel this function during the process. You will hear 2 beeps when it's finished or cancelled.

- It's normal if there is some noise during this function process, as plastic materials expand with heat and contract with cold.
- We suggest operating this function at the following ambient conditions to avoid certain safety protection features.
- It's suggested to utilize this function every 3 months.

8 HEATING FUNCTION (Optional)

1. Long press **ECO** button over 3 seconds to active this function, and 8°C (46°F) will appear on the remote display. Do it again to deactivate this function.
2. This function will auto start the heating mode when the room temperature is lower than 8°C (46°F), and it will return to standby if the room temperature reaches 9°C (48°F).
3. If the room temperature is higher than 18°C (64°F), the appliance will cancel this function automatically.

GENTLE WIND FUNCTION (Optional)

Turn on the indoor unit, and change to COOL mode, then press **GENTLE WIND** button or to active this function,  will appear on the display. Do it again to deactivate it.

This function will auto close the vertical flaps, and give you the comfortable gentle wind feeling.

HEALTH FUNCTION (OPTIONAL)

1. Turn on the indoor unit at first, press HEALTH to active this function,  will appear on the display. Do it again to deactivate it.
2. When the **HEALTH** function is initiated, the Ionizer / Plasma / Bipolar Ionizer / UVC Lights (depending on models) will be energized and running.

RESET WI-FI

Method 1: Press button DISPLAY 6 times in 8 seconds.

Method 2: Press button ECO 6 times in 8 seconds.

Method 3: Long press MODE and over 3 seconds.

You will hear 2 beeps and CF or AP will show on the indoor display after the operation.

FRESH AIR FUNCTION

FRESH AIR

This function will pump the fresh air from outside to inside

Continue press **FRESH AIR** button until select your desired Fresh Air fan speed or deactivate this function as circulation **Low-Mid-High-OFF**, then loose button.

The following indicator will appear on the display:

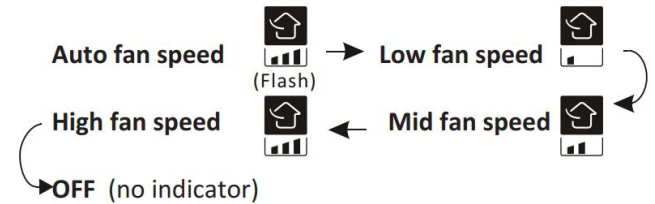

Note:

- This function is available when in OFF/Heating Cooling/Fan/Auto mode.

- In OFF mode, the system may run automatically because of the big difference of temperature between indoor and outside.

- If the indoor display shows the Fresh Air indicator and shows CL. You can replace the filter and long press button **FRESH AIR** over 5 seconds to clear the indicator CL



+49 7941 6433976
bauf-home.de
support@bauf-home.de